

铣削刀片

Milling inserts

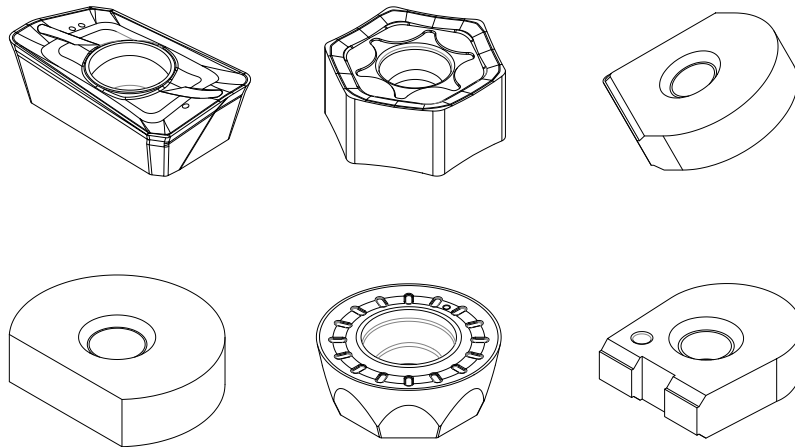
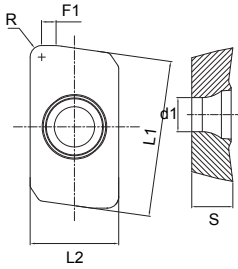

AP**

形状 Shape	型号 Type	尺寸 Dimension (mm)						牌号 Brand		
		L1	L2	S	F1	D1	R	GU20	GM15	GM25
	APMT1135PDER-H2	10.8	6.2	3.65	1.87	2.80	0.8	•	•	
	APMT1604PDER-H2	16.3	9.3	4.91	2.21	4.40	0.8	•	•	
	APMT1135PDER-M2A	10.8	6.2	3.65	2.07	2.80	0.8	•	•	
	APMT1604PDER-M2A	16.3	9.3	4.91	2.10	4.40	0.8	•	•	
	APMT1135-DL	10.9	6.2	3.62	2.05	2.80	0.8		•	
	APMT1604-DL	16.1	9.3	5.35	1.93	4.40	0.8		•	

RP*

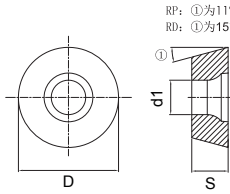
形状 Shape	型号 Type	尺寸 Dimension (mm)			牌号 Brand		
		D	S	D1	GU20	GM15	GM25
	RPMW1003M0-HM	10.00	3.18	4.40	•	•	
	RPMW1204M0-HM	12.00	4.76	4.40	•		
	RPMT1204MO-DL	12.00	4.76	4.40	•	•	

RD*

形状 Shape	型号 Type	尺寸 Dimension (mm)			牌号 Brand		
		D	S	D1	GU20	GM15	GM25
	RDMW10T3M0	10.00	4.12	4.40	•	•	
	RDMT10T3M0	10.00	4.12	4.40	•		
	RDMW1204MOT-PR	12.00	4.76	4.40	•	•	
	RDMW120400-PR	12.00	4.76	4.40	•		
	RDMW1204M0T-PM	12.00	4.76	4.40	•	•	
	RDMW1605M0T-PM	16.00	5.81	5.50	•		

SDMT

形状 Shape	型号 Type	尺寸 Dimension (mm)			牌号 Brand			
		I.C	T	R	GK05	GU20	GM15	GM25
	SDMT120512-HM	12.70	5.56	1.2				
	SDMT150512-HM	15.88	5.56	1.2				

面铣刀

Face Milling Inserts

HN

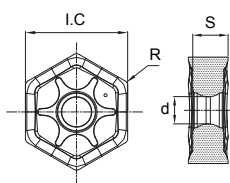
形状 Shape	型号 Type	尺寸 Dimension (mm)					牌号 Brand			
		I.C	D	S	R	α	GU25UF	GP35	GM15	GM25
	HNMJ060408	10.20	4.00	4.75	0.8	-	•			
	HNMX090608	16.20	5.00	6.36	0.8	-	•			

OE/OD/OP

形状 Shape	型号 Type	尺寸 Dimension (mm)					牌号 Brand			
		I.C	D	T	R	α	GK05	GP25	GP35	GM25
	OEXW060400	14.40	4.75	4.95	-	20.0			•	
	OEMW160502	15.87	5.18	4.95	0.20	20.0		•		
	ODMT040408	12.70	4.70	4.76	0.80	15.0				•
	ODXT090304	8.84	3.56	3.56	0.38	15.0				•
	OPXT160512	15.72	5.59	5.5	1.19	11.0				•

球头刀

Ball Milling Inserts

GFB-H

形状 Shape	型号 Type	尺寸 Dimension (mm)			牌号 Brand	
		R	D	T	GU20	GU25UF
	GFB-H10	5.0	4.00	2.70		•
	GFB-H11	5.5	4.00	2.70		•
	GFB-H12	6.0	5.00	3.20		•
	GFB-H13	6.5	5.00	3.20		•
	GFB-H16	8.0	5.00	4.20		•
	GFB-H17	8.5	5.00	4.20		•
	GFB-H20	10.0	6.00	5.20		•
	GFB-H21	10.5	6.00	5.20		•
	GFB-H25	12.5	6.00	6.20		•
	GFB-H26	13.0	6.00	6.20		•
	GFB-H30	15.0	8.00	7.20		•

GFB-W

形状 Shape	型号 Type	尺寸 Dimension (mm)			牌号 Brand		
		R	D	T	GU10	GU20	GU25UF
	GFB-W10	5.0	4.00	2.70	•		•
	GFB-W12	6.0	5.00	2.70	•	•	•
	GFB-W16	8.0	5.00	3.20	•	•	•
	GFB-W20	10.0	5.00	3.20	•	•	•
	GFB-W25	12.5	6.00	4.20	•	•	•
	GFB-W30	15.0	8.00	5.20	•	•	•
	GFB-W32	16.0	8.00	5.20	•	•	•

GFB-D

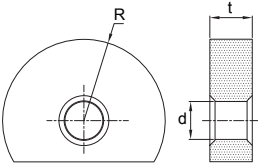
形状 Shape	型号 Type	尺寸 Dimension (mm)			牌号 Brand		
		R	D	T	GU10	GU20	GU25UF
	GFB-D1203	6.0	3.50	3.00		•	•
	GFB-D1604	8.0	4.00	4.00		•	•
	GFB-D2005	10.0	5.00	5.00		•	•
	GFB-D2506	12.5	6.00	6.00		•	•
	GFB-D3007	15.0	8.00	7.00		•	•

GFB-C

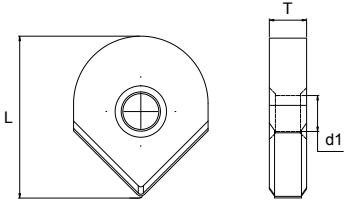
形状 Shape	型号 Type	尺寸 Dimension (mm)			牌号 Brand		
		R	D1	T	GU10	GU20	GU25UF
	GFB-C21703	12.7	5.21	3.70	•		
	GFB-C22104	15.9	5.51	4.40	•		
	GFB-C22405	19.1	8.89	5.20	•		
	GFB-C23305	25.4	6.35	6.00	•		
	GFB-C24106	31.8	8.50	6.80	•		

圆鼻铣刀

Ball Nose Inserts

*YNC

形状 Shape	型号 Type	尺寸 Dimension (mm)				牌号 Brand			
		L	W	D	D1	GK05	GU20	GM15	GM25
	YNC21102	1.8	10.00	2.51	3.73		•		
	YNC21403	14.7	12.70	3.71	4.50		•		
	YNC21404	14.1	12.00	2.54	3.73		•		
	YNC21804	18.2	15.88	4.47	5.21		•		
	YNC22205	23.0	19.05	5.46	5.21		•		
	YNC22405	24.8	20.02	5.46	5.21		•		
	YNC22905	29.3	25.40	5.33	8.89		•		

LNMC

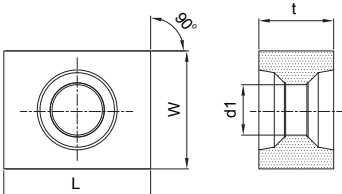
形状 Shape	型号 Type	尺寸 Dimension (mm)				牌号 Brand			
		L	W	T	D1	GK05	GU20	GM15	GM25
	LNMC120500	12.7	12.70	5.56	4.50	•			
	LNMC130600	12.7	12.70	6.35	5.20	•			
	LNMC150700	15.9	12.70	7.94	5.60			•	
	LNMC150802	15.9	15.88	7.94	5.60				
	LNMC190602	19.1	14.30	6.35	5.80			•	
	LNMC250500	25.4	14.30	4.76	5.40	•			
	LNMC251200	25.4	15.88	12.70	6.50			•	